Operation Manual

FreeStyle T44/T24 LED

(True Match® Firmware 5.0)
(RDM)



CFX-F484



FS-48
FS-24



LED-140X



KINO FLO
Lighting Systems

FreeStyle T44/T24 Systems



SYS-FT44U

FreeStyle T44 LED DMX System, Univ

SYS-FT24U

FreeStyle T24 LED DMX System, Univ

FreeStyle T44/T24 LED System consists of:

- 1 FreeStyle T44/T24 Fixture
- 1 Mounting Plate
- 1 FreeStyle/4 Extension Cable
- 1 LED Controller
- 4 FreeStyle 4ft (or 2ft) LED Tubes

FreeStyle T44/T24 System Components



CFX-F484 FreeStyle T44 Fixture

CFX-F244 FreeStyle T24 Fixture



FS-48 FreeStyle 4ft LED Tube

FS-24 FreeStyle 2ft LED Tube



MTP-KG41 KinoGrip 41K Mount w/ 3/8" Pin (10mm)



X12-F425 FreeStyle/4 Extension, 25ft



LED-140X-120U

FreeStyle 140 LED DMX Controller, Univ 120U

LED-140X-230U

FreeStyle 140 LED DMX Controller, Univ 230U

FreeStyle 4-Tube Systems



SYS-FTS4004

FreeStyle 4ft LED DMX System (4-Tube), Univ

SYS-FTS2004

FreeStyle 2ft LED DMX System (4-Tube), Univ

FreeStyle 4ft/2ft LED System (4-Tube) consists of:

- 1 LED Controller
- 1 Splitter
- 4 Extension Cable
- 4 Baby Pin (16mm)
- 4 FreeStyle 4ft (or 2ft) LED Tubes

FreeStyle 4-Tube System Components



FS-48 FreeStyle 4ft LED Tube

FS-24 FreeStyle 2ft LED Tube



MTP-F101 FreeStyle Tube Mount - Baby Pin (16mm)



X08-F125 FreeStyle/1 Extension, 25ft



X12-A4 FreeStyle/4 to FreeStyle/1 Splitter



LED-140X-120U

FreeStyle 140 LED DMX Controller, Univ 120U

LED-140X-230U

FreeStyle 140 LED DMX Controller, Univ 230U

FreeStyle T44 LED DMX Kits



**FreeStyle T44 LED DMX Kit
w/ Soft Case**

KIT-FT44BU

FreeStyle T44 LED DMX Kit w/ Soft Case, Univ

Kit Contents:

- 1 FreeStyle T44 LED Fixture
- 4 FreeStyle 4ft LED Tube
- 1 FreeStyle 140 LED DMX Controller
- 1 MTP-BG41 Mount w/ Baby Receiver (16mm)
- 1 FreeStyle/4 Extension, 25ft
- 1 Soft Case

Dimensions:

55 x 8 x 19.5"
(140 x 20.5 x 49.5cm)

Weight:

25 lb
(11kg)



**FreeStyle T44 LED DMX Kit
w/ Travel Case**

KIT-FT44U

FreeStyle T44 LED DMX Kit w/ Travel Case, Univ

Kit Contents:

- 1 FreeStyle T44 LED Fixture
- 4 FreeStyle 4ft LED Tube
- 1 FreeStyle 140 LED DMX Controller
- 1 MTP-BG41 Mount w/ Baby Receiver (16mm)
- 1 FreeStyle/4 Extension, 25ft
- 1 Travel Case

Dimensions:

54.5 x 9 x 21"
(138 x 23 x 53cm)

Weight:

44.5 lb
(20kg)



**FreeStyle T44 Gaffer LED
DMX Kit (2-Unit)**

KIT-FT44GU

FreeStyle T44 Gaffer LED DMX Kit, Univ (2-Unit)

Kit Contents:

- 2 FreeStyle T44 LED Fixture
- 8 FreeStyle 4ft LED Tube
- 2 FreeStyle 140 LED DMX Controller
- 2 MTP-BG41 Mount w/ Baby Receiver (16mm)
- 2 FreeStyle/4 Extension, 25ft
- 1 Ship Case

Dimensions:

56.5 x 13 x 16.5"
(143.5 x 33 x 42cm)

Weight:

70.5 lb
(32kg)

FreeStyle T24 LED DMX Kits



**FreeStyle T24 LED DMX Kit
w/ Soft Case**

KIT-FT24BU

FreeStyle T24 LED DMX Kit w/ Soft Case, Univ

Kit Contents:

- 1 FreeStyle T24 LED Fixture
- 4 FreeStyle 2ft LED Tube
- 1 FreeStyle 140 LED DMX Controller
- 1 MTP-BG41 Mount w/ Baby Receiver (16mm)
- 1 FreeStyle/4 Extension, 25ft
- 1 Soft Case

Dimensions:

31 x 7.5 x 18"
(79 x 19 x 46cm)

Weight:

21 lb
(9.5kg)



**FreeStyle T24 LED DMX Kit
w/ Travel Case**

KIT-FT24U

FreeStyle T24 LED DMX Kit w/ Travel Case, Univ

Kit Contents:

- 1 FreeStyle T24 LED Fixture
- 4 FreeStyle 2ft LED Tube
- 1 FreeStyle 140 LED DMX Controller
- 1 MTP-BG41 Mount w/ Baby Receiver (16mm)
- 1 FreeStyle/4 Extension, 25ft
- 1 Travel Case

Dimensions:

32 x 11 x 18.5"
(81 x 28 x 47cm)

Weight:

33 lb
(15kg)



**FreeStyle T24 Interview LED
DMX Kit (2-Unit)**

KIT-FT24NU

FreeStyle T24 Interview LED DMX Kit, Univ (2-Unit)

Kit Contents:

- 2 FreeStyle T24 LED Fixture
- 8 FreeStyle 2ft LED Tube
- 2 FreeStyle 140 LED DMX Controller
- 2 MTP-BG41 Mount w/ Baby Receiver (16mm)
- 2 FreeStyle/4 Extension, 25ft
- 1 Ship Case

Dimensions:

36 x 13 x 16.5"
(91.5 x 33 x 27cm)

Weight:

59.5 lb
(27kg)

Power



AC Input

The FreeStyle 140 LED DMX Controller is powered AC and includes an IEC connection. It also includes a 12ft power cord with a locking IEC connector.

The FreeStyle 140 LED DMX has a built-in power supply with universal input from 100-240VAC.

Ambient Operating Temperature

The FreeStyle 140 LED DMX is designed to operate at temperatures from 14°F to 104°F (-10°C to 40°C).



DC Input

The FreeStyle 140 LED DMX can also be operated on 24VDC (input range 18-36VDC) through a 3-Pin XLR. The pin polarity is:

- Pin # 1 – Ground
- Pin # 2 + 18-36VDC
- Pin # 3 not used



Note:

A low voltage warning will display if input DC voltage is under 18VDC. Photo example: **LOW VDC: 16**

FreeStyle Fixture Assembly

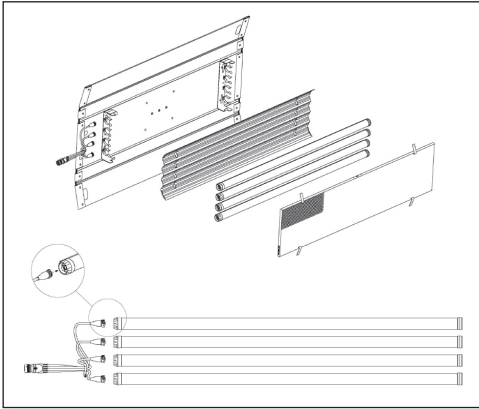

The FreeStyle T44/T24 fixture is comprised of a Louver, Reflector and Tube Harness.

The Louver and Reflector are held in place with Velcro fasteners. The Tube Harness is secured by means of a $\frac{1}{4}$ turn fastener.



The FreeStyle Reflector has a unique design to accommodate the aluminum channel on the back of the FreeStyle tube. It provides even light distribution and maximizes light output. In addition, it acts as a heatsink and allows the FreeStyle Tubes to run cooler.

FreeStyle Tube Assembly

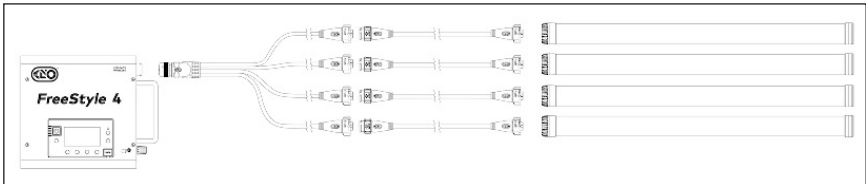

The FreeStyle Tubes can operate outside the fixture with just the harness. FreeStyle Tube systems are available in 4ft and 2ft.

MTP-F101

FreeStyle Harness



FreeStyle Harness:

Align arrows on harness connector with tube. Push and click into place. To remove harness connector, turn locking ring to the left and pull.



Push tubes into the fixture's tube holder clips. The tubes can operate independent of the fixture allowing them to be built into sets or custom soft boxes or hand-held as a single tube for an eye-light.



To Release the Tube Harness

Rotate the $\frac{1}{4}$ turn fastener clockwise to release harness.



The harness connects directly to the controller. Connect the harness to the controller. Align the key ways on the harness connector with the oval **Logo** at the top with the circular receptacle on the ballast. Rotate the silver locking ring until it clicks into the lock position.



Extension Cable



X12-F425

The FreeStyle LED fixture can operate remotely from the controller with the extension cable up to 50ft (2 x 25ft). Remote operation of the controller provides more rigging options.

To connect Harness to Extension Cable, align oval **Logos** on the Harness and Extension. Rotate the silver locking ring until it clicks into the locked position.

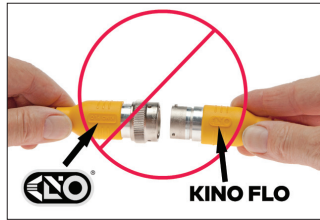
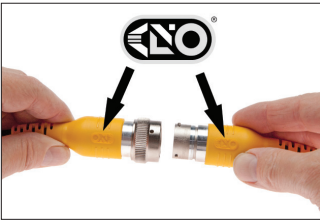

The FreeStyle Tubes can operate outside the fixture with just the harness. For further versatility, a splitter (X12-A4) and FreeStyle Single extension cables (X08-F125) (x4) (both sold separately) can be used to operate the tubes remotely. FreeStyle Tube systems are available in 4ft and 2ft.

To connect Harness to Adapter Cable, align oval **Logos** on the Harness and Adapter Cable. Rotate the silver locking ring until it clicks into the locked position.



X12-A4



X08-F125

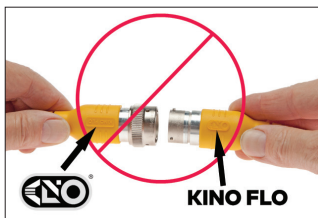

Mounting Controller



The Controller can be mounted to a stand with a ballast mount accessory, **MTP-BAL1** and mafer clamp.

MTP-BAL1



Mounting the Fixture



The standard mount (**MTP-KG41**) comes with a 3/8" Lollipop that clamps into a grip head. The ball and socket mount allows the fixture to be oriented in a broad range of angles.



Align the center pin of the mounting plate to the center hole on the mating plate.

Rotate plate clockwise until the four shoulder rivets drop into the receptacle. A locking pin will snap into place when the plate is properly seated.

The **yellow wire loops** provide attachment points for a safety chain.



To remove the plate, pull up on the locking pin and reverse the mounting procedure.

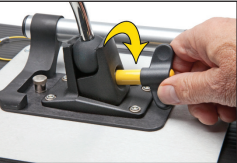

Turn the knob to loosen or tighten the mount.



Lollipops are interchangeable.

MTP-L Kino 41 Lollipop w/ 3/8" Pin (10mm)

MTP-LBC Kino 41 Lollipop w/ Baby Rcvr Curve (16mm)

MTP-LBS Kino 41 Lollipop w/ Baby Rcvr Short (16mm)

Mounting LED Tubes

FreeStyle LED Tubes can operate inside the fixture or independently with only the wiring harness. The LED Tubes have an aluminum rail that can be used as an access point for mounting accessories:

MTP-F100	FreeStyle Tube Mount – Anchor
MTP-F101	FreeStyle Tube Mount – Baby Pin
MTP-F102	FreeStyle Tube Mount – Wall Plate
MTP-F103	FreeStyle Tube Mount – Hanging Kit 4pk (Wire not included)
MTP-F103W	FreeStyle Tube Mount – Hanging Wire, 50ft
MTP-F105	FreeStyle Tube Mount – Combiner
MTP-F200	FreeStyle Tube -Ball Mount
MTP-F201	FreeStyle Tube - Floor Stand



MTP-F100



MTP-F101



MTP-F102



MTP-F103



MTP-F103W



Insert into T-slot. Insert wire all the way down. Pull up wire until it latches. Press down pin to release wire.



MTP-F105



The FreeStyle Tube Mount Combiner (**MTP-F105**) can mount two LED tubes. Insert into T-slot and tighten thumbscrew. Several Combiners can be combined for custom rigging applications.



MTP-F200



MTP-F201



The FreeStyle Tube Ball Mount (**MTP-F200**) includes a baby receiver and works together with the FreeStyle Tube Floor Stand (**MTP-F201**) which includes a baby pin.



The FreeStyle Tube Ball Mount (**MTP-F200**) can also be used in conjunction with a baby pipe clamp.

Applying Louver



The Louver is fastened to the fixture with 4 Velcro straps.

Applying Flozier



Remove Louver. Stretch two elastic cords around fixture. Take up slack on both elastic cords.



Expand the barndoors to Smooth out the face of the Flozier and eliminate wrinkles.

Control Panel - White Mode

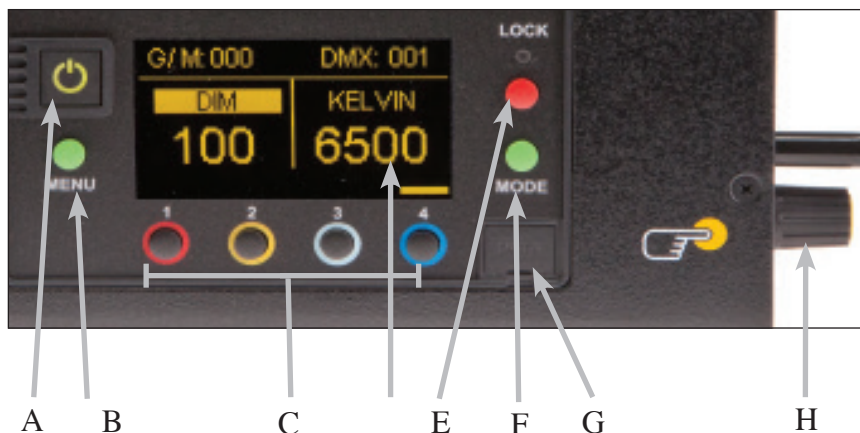

A) On /Off: **On** = Green light displayed. **Off** = Red light displayed. The display and all menu settings can be operated while the power button is in the Off position, as long as power is applied to the controller. The On /Off button only controls the light source.

B) Menu: Provides access to menu options such as General settings, Reset, DMX, DMX Wireless, Camera LUT and Color Space.
Shortcut: While on control screen, press and hold for 3 seconds to switch through menus (**White, Gels & Hue, RGB, CIE xy and FX**).

C) Preset Buttons: Factory defaults left to right are: 2700K, 3200K, 5000K and 6500K. G/M default value is 000. User can also use these preset buttons to store custom Kelvin and G/M settings.

D) Display: Provides access to Dim, Kelvin, G/M, and DMX channel.
Factory reset will show: Dim = 10%, Kelvin = 2700K, G/M = 000, DMX = 001.

E) Lock: Press the **Lock** button to disable all buttons and Control knob.
Press for 3 seconds to restore displayed presets to default factory settings.

F) Mode: Press to navigate from Dim to Kelvin and G/M settings.
When in sub-menus, pressing Mode always returns you to main display.
When DMX is applied, use Mode to access DMX channel on main display.
Shortcut: Long press will bring you back one step.

G) Data Port: Mini B USB for firmware updates.

H) Control Knob: Manually adjusts Dim, Kelvin, G/M levels and DMX address.
Press the Control knob to toggle between **Fine** and **Coarse** increments or when selecting options within menus.

DMX Note: The LED-140X has an **"AUTO TERMINATE"** feature.
The last fixture that does not have an XLR cable attached to the DMX "Out" port will automatically terminate.

Control Panel - Gels/Hue Mode

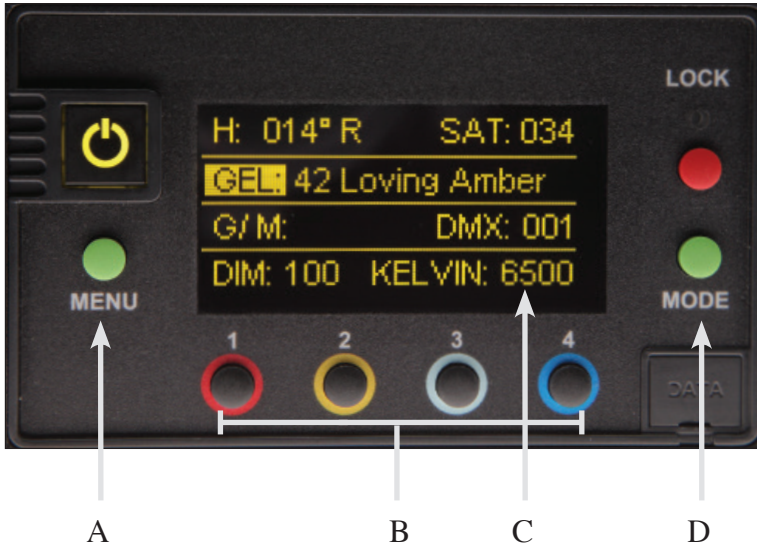

Gels/Hue Mode

A) Menu:

Provides access to menu options such as General settings (**Gels/Hue Mode**), Reset, DMX, DMX Wireless, Camera LUT and Color Space.

Shortcut: While on control screen, press and hold for 3 seconds to switch through menus (**White, Gels & Hue, RGB, CIE xy and FX**).

B) Preset Buttons:

Factory defaults left to right are: 2700K, 3200K, 5000K and 6500K.

G/M default value is 000. User can also use these preset buttons to store custom Kelvin between 2500K and 9900K and custom G/M, Gel, Hue and Saturation settings.

C) Display:

Provides access to Dim, Kelvin, G/M, Gel, Hue/Saturation and DMX channel. Factory reset will show: Dim = 10%, Kelvin = 2700K, G/M = 000, DMX = 001.

D) Mode:

Press to navigate from Dim to Kelvin, G/M, Gel, Hue and Saturation settings. When on the Gel function, pushing the Control knob in/out will apply the gel or remove the gel. When in sub-menus, pressing Mode always returns you to main display. When DMX is applied, use Mode to access DMX channel on main display. Shortcut Tip: Long press will bring you back one step.

Control Panel - RGB Mode

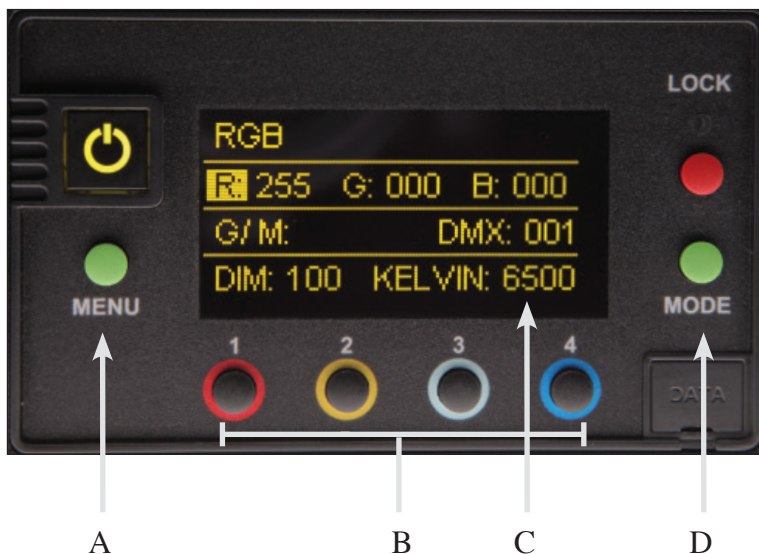

RGB Mode

A) Menu:

Provides access to menu options such as General settings (**RGB Mode**), Reset, DMX, DMX Wireless, Camera LUT and Color Space.

Shortcut: While on control screen, press and hold for 3 seconds to switch through menus (**White, Gels & Hue, RGB, CIE xy and FX**).

B) Preset Buttons:

Factory defaults left to right are: 2700K, 3200K, 5000K and 6500K.

G/M default value is 000. User can also use these preset buttons to store custom Kelvin between 2500K and 9900K and custom G/M, and RGB settings.

C) Display:

Provides access to Dim, Kelvin, G/M, RGB and DMX channel.

Factory reset will show: Dim = 10%, Kelvin = 2700K, G/M = 000, DMX = 001.

D) Mode:

Press to navigate from Dim to Kelvin, G/M, RGB settings.

When in sub-menus, pressing Mode always returns you to main display.

When DMX is applied, use Mode to access DMX channel on main display.

Shortcut: Long press will bring you back one step.

Control Panel - CIE xy

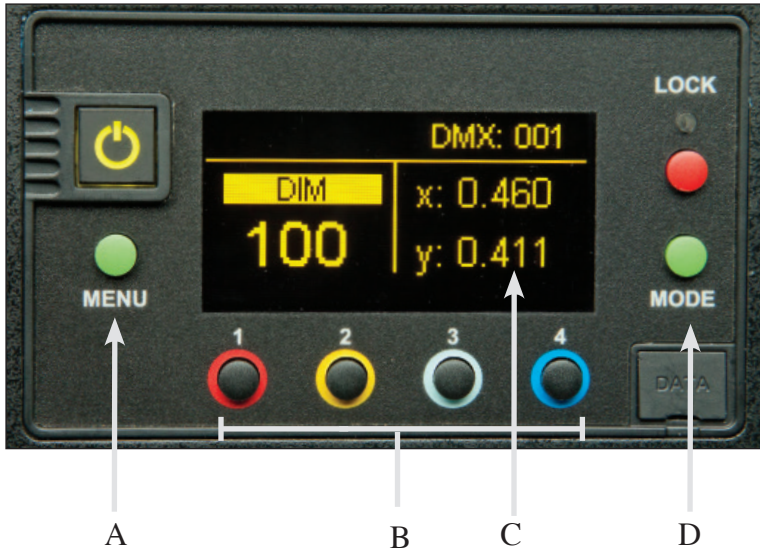

CIE xy Mode

A) Menu:

Provides access to menu options such as General settings (**CIE xy mode**), Reset, DMX, DMX Wireless, Camera LUT and Color Space.

Shortcut: While on control screen, press and hold or 3 seconds to switch through menus (**White, Gels & Hue, RGB, CIE xy and FX**).

B) Preset Buttons:

Factory defaults left to right are: 2700K, 3200K, 5000K and 6500K. User can also use these preset buttons to store custom xy settings.

C) Display:

Provides access to Dim, CIE xy coordinates and DMX Channel. Factory reset will show: Dim = 10%, x = 0.460 , y = 0.411, G/M = 000, DMX = 001.

D) Mode:

Press to navigate from Dim to xy settings. When in sub-menus, pressing Mode always returns you to main display. When DMX is applied, use Mode to access DMX channel on main display. Shortcut: Long press will bring you back one step.

Control Panel - FX (Effects)

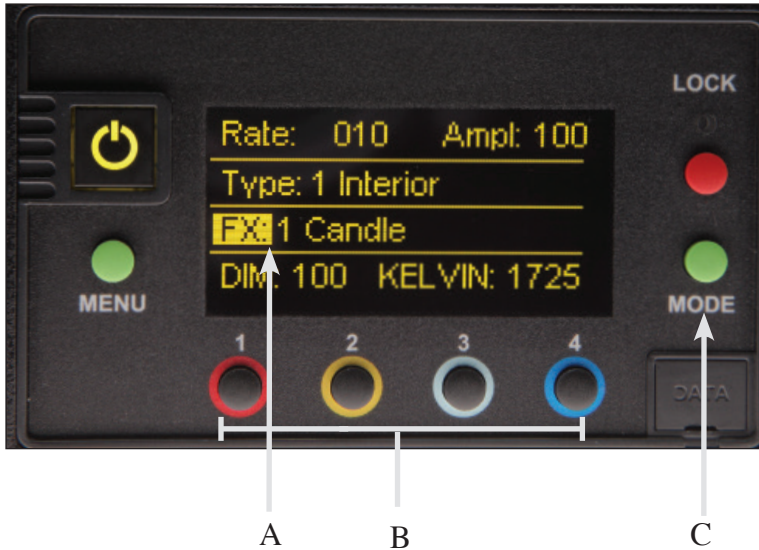

FX (Effects) Mode

FX mode provides access to effects including Candle, Fire, TV, Police, Lightning, Paparazzi, Pulse and Scroll. Candle mode used as an example:

A) FX Option:

Choose the desired FX Mode by rotating the control knob. When on the desired effect, there will be several pre-programmed effects as well as control parameters that can be altered.

B) Preset Buttons:

In FX Mode, **Kelvin** custom settings and any control functions displayed such as **Rate** and **Amplitude (Ampl)** can be saved as a preset. Chosen values can be assigned to any preset button by holding down the desired button for 3 seconds. The Kelvin display will flash once the setting is registered.

To restore presets to default factory settings, choose **Reset** under **General** settings and **Clear Presets**. This method will reset all buttons in all Modes. Shortcut: If only want to clear presets for **Candle** Mode, hold **Lock** button for 3 seconds while Candle mode is displayed.

C) Mode:

Press to navigate from Dim to Kelvin and FX settings.
Shortcut: Long press will bring you back one step.

Camera LUT



The **Camera LUT** (Look-up Tables) feature harmonizes the Kino Flo light sources to the camera. Depending on the camera and the Kelvin setting, some differences are very subtle, while others can be more dramatic.

The corrections are applied as a **CIE xy** correction at each CCT (Kelvin) setting. The default setting is targeting the CIE xyz response (human eye).

Press the green menu button to the left of the display screen and scroll down to **Camera LUT**, then press the control knob. Menu with camera selection will be displayed. Turn the control knob and press to select camera setting:

- C1 Arri Alexa**
- C2 Sony Venice**
- C3 Panavision DXL**
- C4 Panasonic Varicam**

The camera code (C1 for Arri Alexa), for example, will appear on the main menu between **DIM** and **CCT** to designate that a camera setting is active.

Note: When the controller is reset, the camera settings will go to Kino Flo Default mode.

Color Space



Color Space defines the RGB color space used and only affects color – not Kelvin. It is used in **RGB** mode and **Hue Angle** and **Saturation**. There are a few instances in the FX (Effects) mode that are also affected when color is used. The RGB color space defines the value of Red, Green, and Blue primaries (in CIE xy) and the white point is fixed at 6500 Kelvin.

Press the green menu button to the left of the display screen and scroll down to **Color Space**, then press the control knob. Menu with color selection will be displayed. Turn the control knob and press to select Color Space options:

rec 709 / sRGB
P3 D65
rec 2020

The color space **rec 709 / sRGB** is commonly used on computer monitors, SDTV and HDTV television. There are slight gamma variations between rec 709 / sRGB, but not enough to separate into 2 color spaces.

The color space **P3 D65** is a common color space for digital movie projection. The color space **rec 2020** is used in ultra high definition television (UHDTV).

The color space is used when the controller is set to the RGB mode and when set to the Hue Angle/ Saturation mode.

In **RGB** mode – the color space designation will be displayed at the top of the menu. When changing the Red, Blue or Green values, the Kelvin will be locked in at 6500 for all color spaces. When the Kelvin is locked in, CCT will be displayed as CCT*. When using Green/Magenta the CCT value is unlocked and color space selection has no impact.

In **Hue Angle/Saturation** mode – the color space designation will be displayed on the Gel line and GEL will be displayed as GEL* and CCT will be displayed as CCT*. The Color space will be displayed only when Hue Angle and Saturation are being used. When using Green/Magenta or Gel, the CCT will be unlocked and color space selection has no impact.

Accessories



SYS-BK12 Block/KF21 Single Battery System, 140Whr, 28.8V (2 x Battery)



DFS-4804 FreeStyle T44 Flozier, Full
DFS-4804-H FreeStyle T44 Flozier, Half
DFS-SL20 FreeStyle T24 Flozier, Full
DFS-SL20-H FreeStyle T24 Flozier, Half

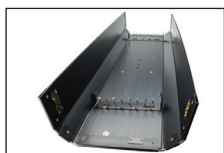

FIX-F484 FreeStyle T44 Fixture Shell Only
FIX-F244 FreeStyle T24 Fixture Shell Only



HAR-FS4 FreeStyle T44/T24 Harness

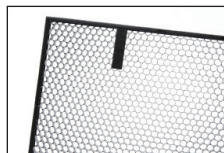

LVR-K490-P FreeStyle T44 Louver/HP, 90°
LVR-K290-P FreeStyle T24 Louver/HP, 90°



MTP-901 Savior Mini Clamp & Lock Screw Pin (16mm)



MTP-902 KF/LED Controller Mount Assembly 2



MTP-903 KF/LED Controller Mount Assembly 3



MTP-F100 FreeStyle Tube Mount – Anchor



MTP-F101 FreeStyle Tube Mount – Baby Pin



MTP-F102 FreeStyle Tube Mount – Wall Plate



MTP-F103 FreeStyle Tube Mount – Hanging Kit 4pk



MTP-F103W FreeStyle Tube Mount – Hanging Wire, 50ft



MTP-F200 FreeStyle Tube - Ball Mount



MTP-F201 FreeStyle Tube - Floor Mount



MTP-BG41 KinoGrip 41K Mount w/ Baby Receiver (16mm)



MTP-BG41S KinoGrip 41K Mount w/
Baby Receiver Short (16mm)



MTP-BAL1 Kino Bal/Led Controller Mount (16mm)



MTP-BRA Baby Right Angle Offset (5/8" Pin)



MTP-L Kino 41 Lollipop w/ 3/8" Pin (10mm)
MTP-LBC Kino 41 Lollipop w/ Baby Rcvr Curve (16mm)
MTP-LBS Kino 41 Lollipop w/ Baby Rcvr Short (16mm)



REF-F484 FreeStyle T44 Reflector
REF-F244 FreeStyle T24 Reflector



X08-F125 FreeStyle/1 Extension, 25ft



X12-A4 FreeStyle/4 to FreeStyle/1 Splitter



XLR-310 3-Pin Xlr DC Power Cable, 10ft



STD-M30 Medium Duty, 3-Rise 30"

STD-M36 Medium Duty, 3-Rise 36"



STD-D1 Reverse Stand

Cases



BAG-401 FreeStyle T44 Soft Case

BAG-SL20 FreeStyle T24 Soft Case



KAS-FT44C FreeStyle T44 Travel Case

KAS-FT24C FreeStyle T24 Travel Case



KAS-FT44G FreeStyle T44 Gaffer Ship Case (2-Unit)

KAS-FT24N FreeStyle T44 Interview Ship Case (2-Unit)



KAS-FT54S FreeStyle T44 Fixture (3) Ship Case

KAS-FT54L FreeStyle T44 Fixture (5) Ship Case

KAS-FT23 FreeStyle T24 Fixture (3) Ship Case



KAS-KFC Ballast and Cable Crate w/ Lid

Fixture Specifications



FreeStyle T44

CFX-F484 FreeStyle T44 LED Fixture

Weight w/ Tubes: 12.5 lb (6kg)

Dimensions: 52 x 3.5 x 13" w/ 6.5" barndoors
(132 x 9 x 33cm w/ 16.5cm barndoors)



FreeStyle T24

CFX-F244 FreeStyle T24 LED Fixture

Weight w/ Tubes: 8 lb (4kg)

Dimensions: 28 x 3.5 x 13" w/ 6.5" barndoors
(71 x 9 x 33cm w/ 16.5cm barndoors)

LED Tube Specifications



FS-48, FS-24

FS-48 FreeStyle 4ft LED Tube

Weight: 1 lb (0.45Kg)

Length: 48" (1200mm)

Diameter (Socket Base): 1.5" (38mm)

Diameter (Including Rail): 1.75" (44.5mm)

FS-24 FreeStyle 2ft LED Tube

Weight: 0.5 lb (0.2Kg)

Length: 24" (600mm)

Diameter (Socket Base): 1.5" (38mm)

Diameter (Including Rail): 1.75" (44.5mm)

LED Controller Specifications



**FreeStyle 140 LED
DMX Controller**

LED-140X FreeStyle 140 LED DMX Controller

AC Input Voltage: 100-240VAC 50/60Hz, 150W

Amperage VAC: 1.25A at 120VAC, 0.65A at 230VAC

DC Input Voltage: 18-36VDC, 150W

Amperage VDC: 6.25A at 24VDC

Kelvin Range: 2500K-9900K

Dimming Range: 100%-1%

Weight: 4.5 lb (2kg)

Dimensions: 9.5 x 7.5 x 2.5"
(24 x 19 x 6cm)

FCC Part 15 Verification:

This device complies with Part 15 of the FCC Rules. Operation is subject to the condition that this device does not cause harmful interference.

FCC Part 15 Declaration of Conformity:

This device complies with Part 15 of the FCC Rules. Operation is subject to the following two conditions: (1) this device may not cause harmful interference, and (2) this device must accept any interference received, including interference that may cause undesired operation.



The light source of this luminaire is not replaceable; when the light source reaches its end of life the whole luminaire shall be replaced. The luminaire is intended for professional use only.



For latest Warranty information and Certifications, see Kino Flo website at www.kinoflo.com.

Environmental: Disposal of Old Electrical & Electronic Equipment.



This symbol on the product or on its packaging indicates that this product shall not be treated as household waste. This product is made of recyclable materials and should be disposed of in accordance with governmental regulations.